

DETAIL A

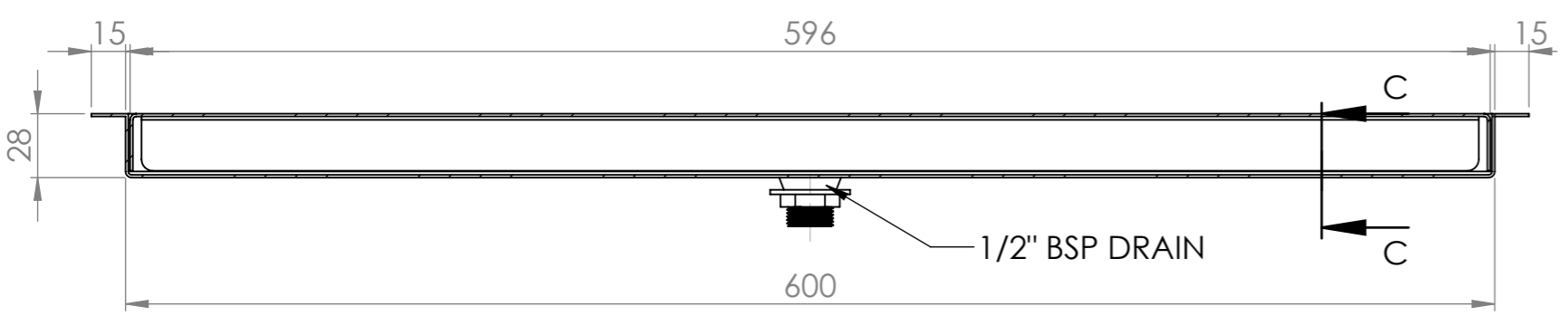

SECTION A-A

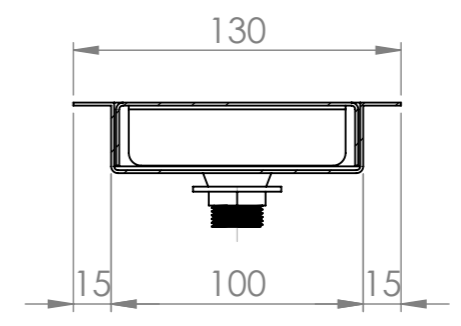

SECTION C-C

SBM-DT-0600

SIMPLY STAINLESS
Modular Bar Solutions

COPYRIGHT © 2022
This drawing is the property of CI GROUP PTY LTD. Tradings as SIMPLY BARS and It may not be copied, reproduced or modified in whole or in part without prior written permission of CI GROUP PTY LTD. SIMPLY BARS reserves the right to change specification and design without notice.

SBM-DT-0600
DROP-IN DRIP TRAY

SIZE: A3

SCALE: 1:3

CONSTRUCTION NOTES:

1. TOPS MADE FROM 1.2mm STAINLESS STEEL.
2. CUT OUT REQUIRED 605mm X 105mm